

Kwadraty

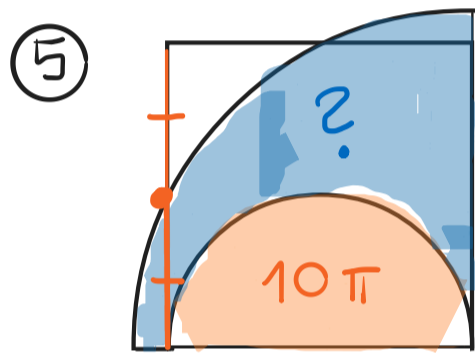

Prostokąty

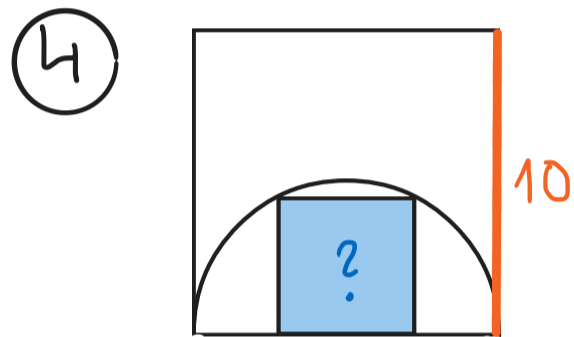
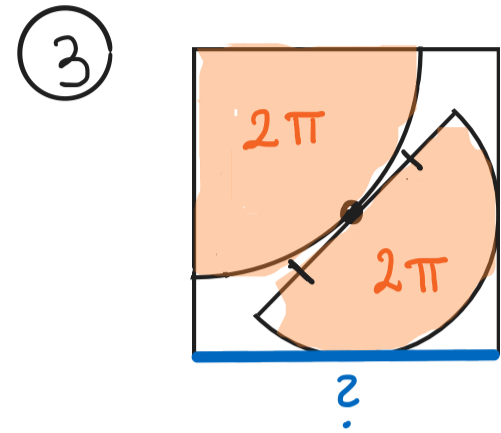
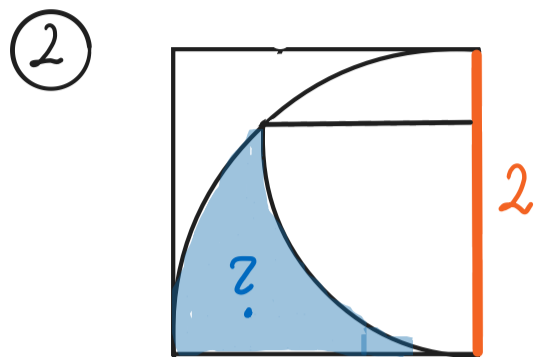
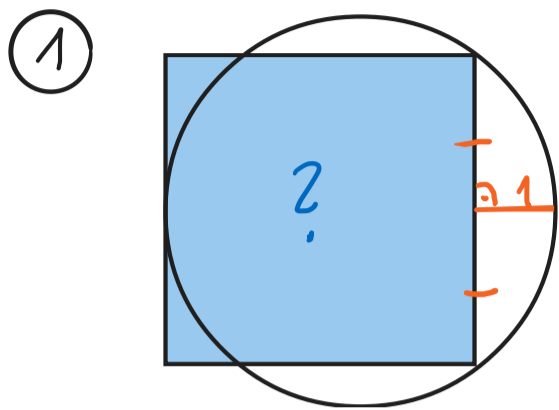
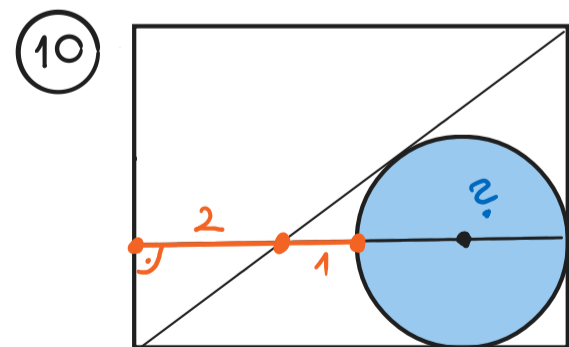
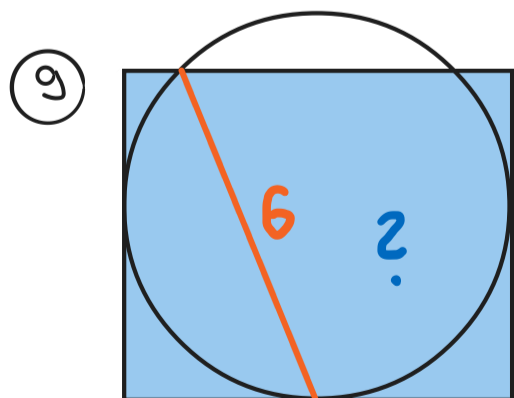
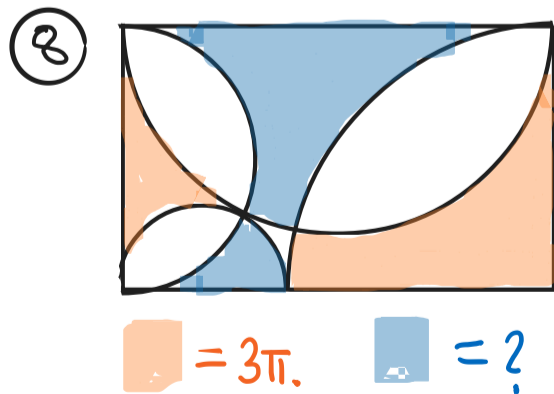
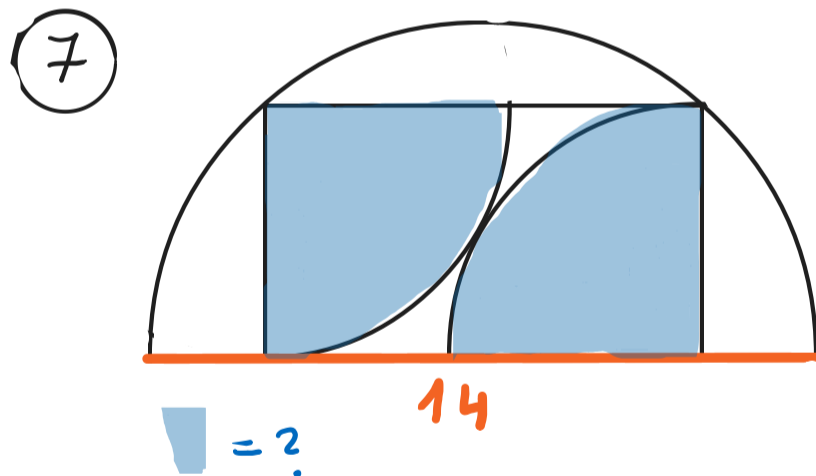
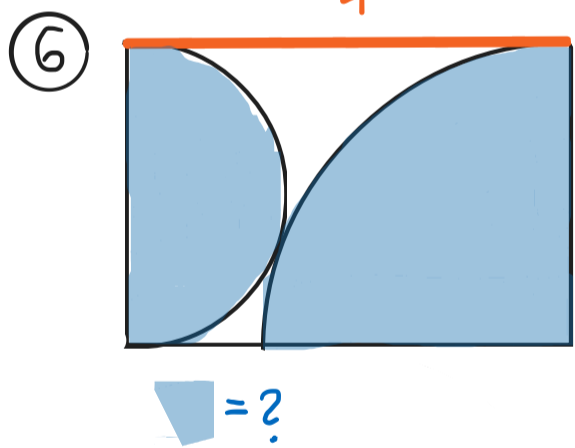

Okręcy

11

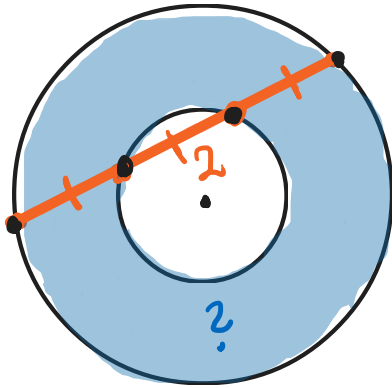

12

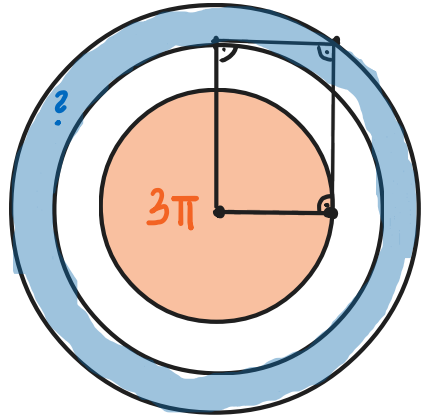

13

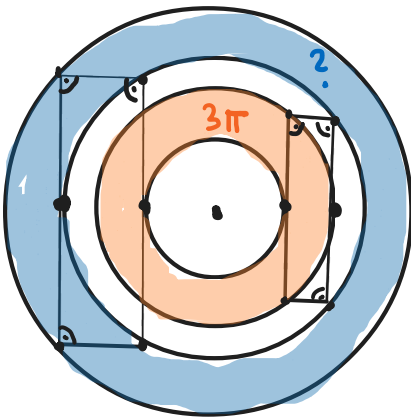

14

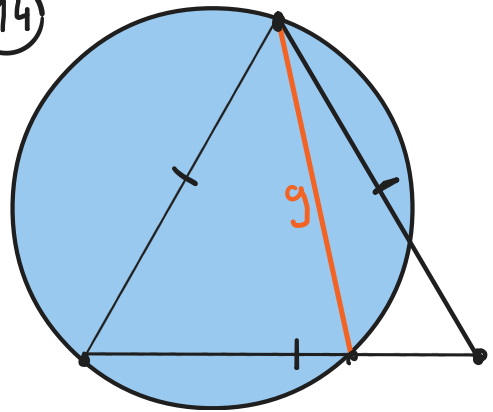

15

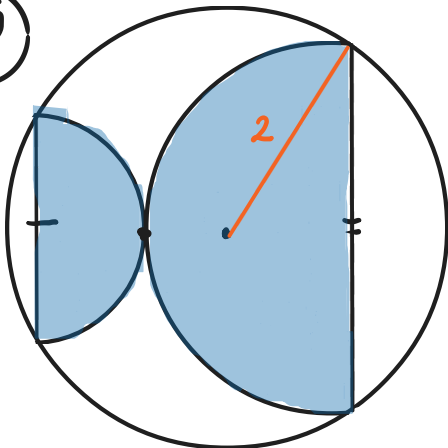

16

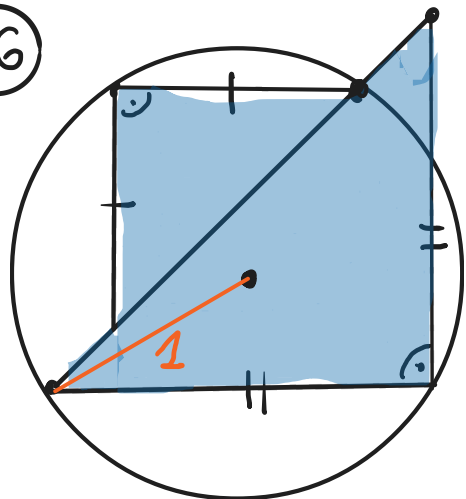

†, ‡ są równoległe.



Półokręgi

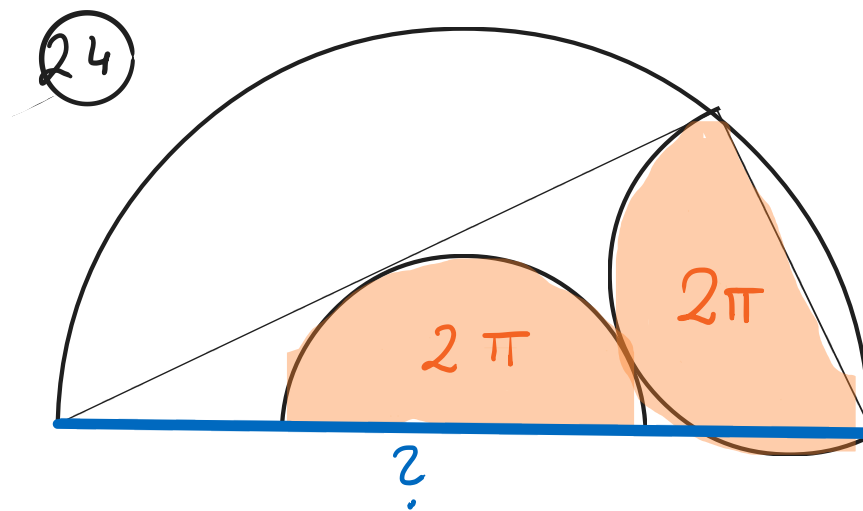
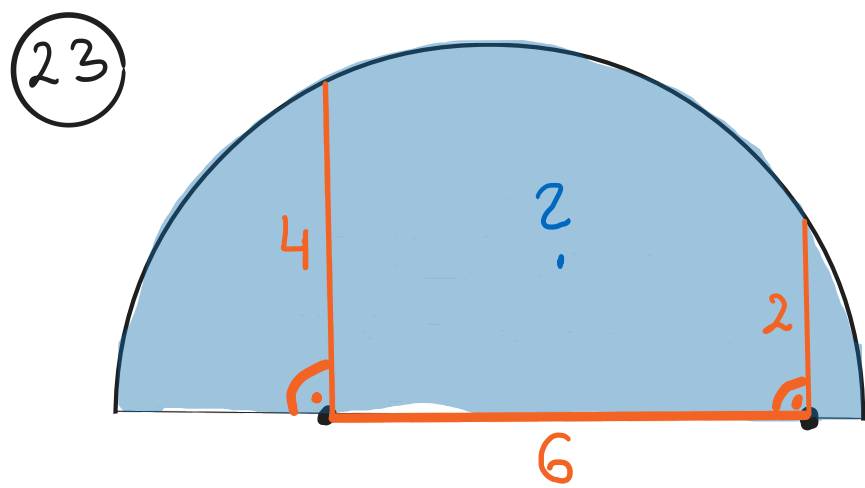
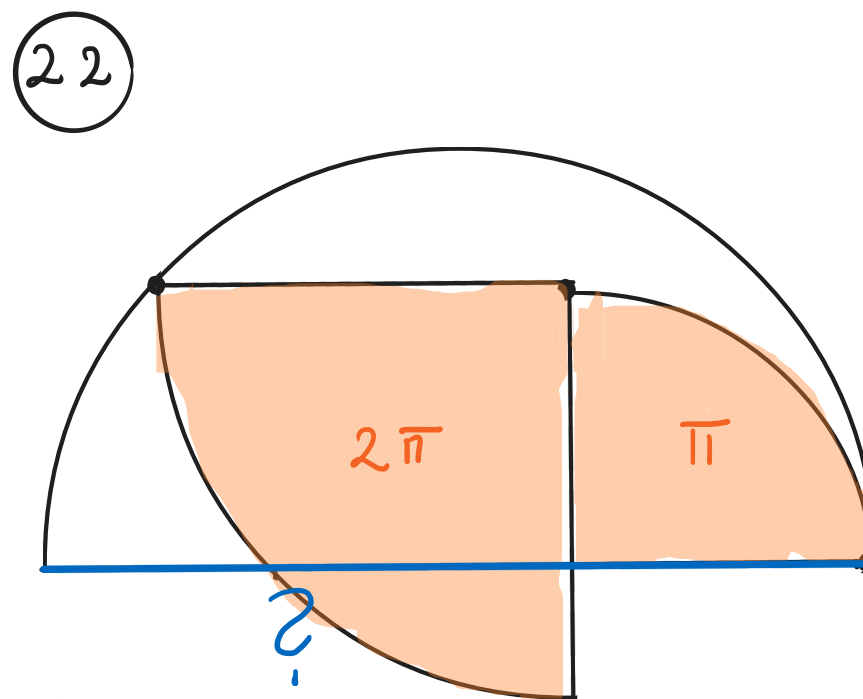
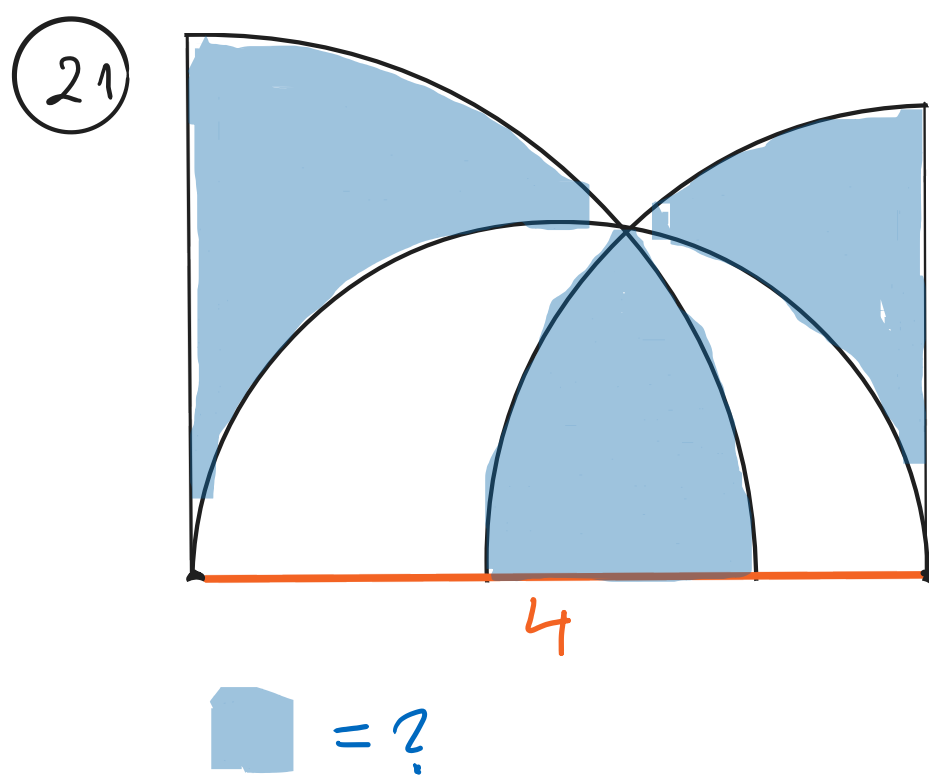
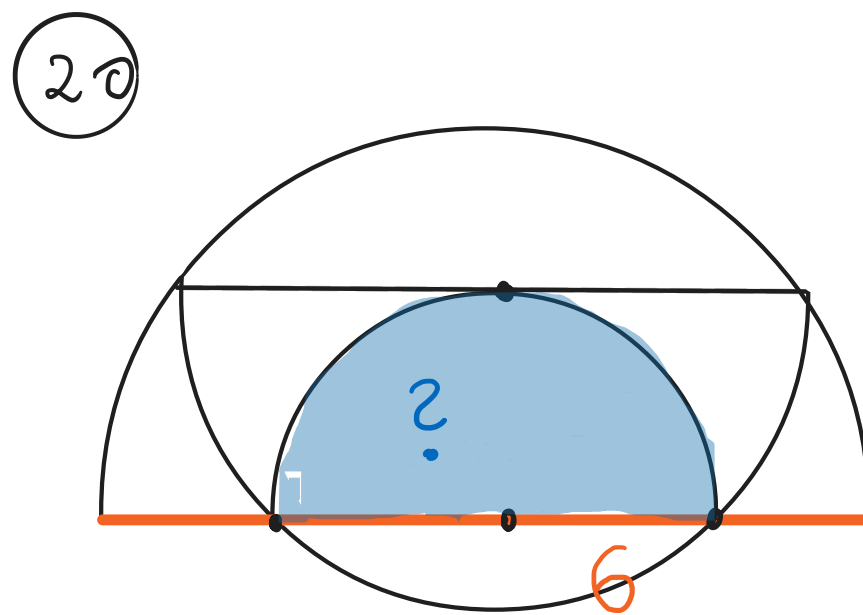
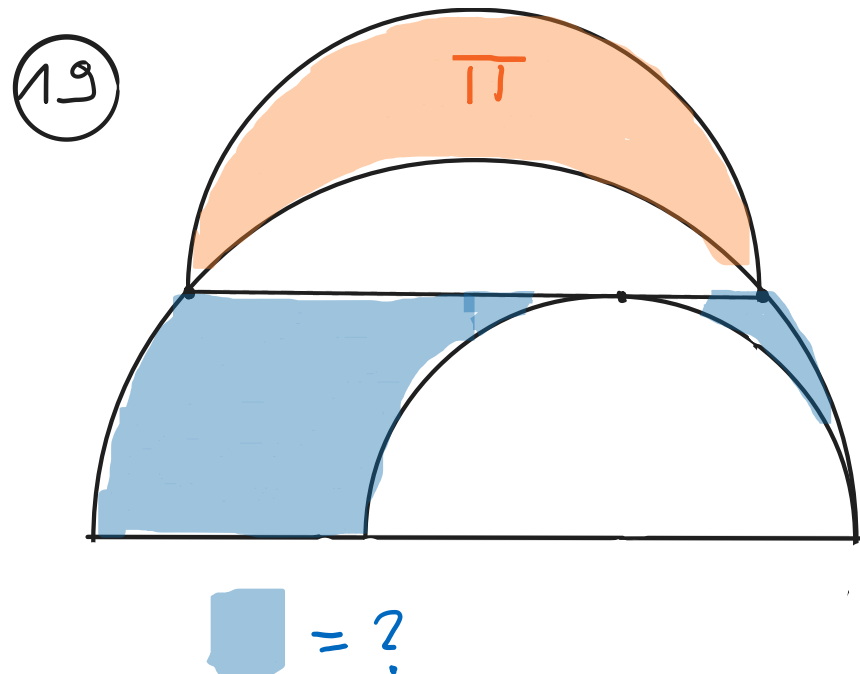
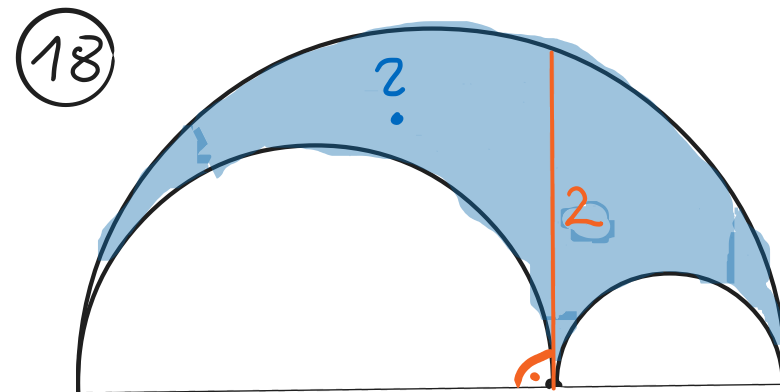
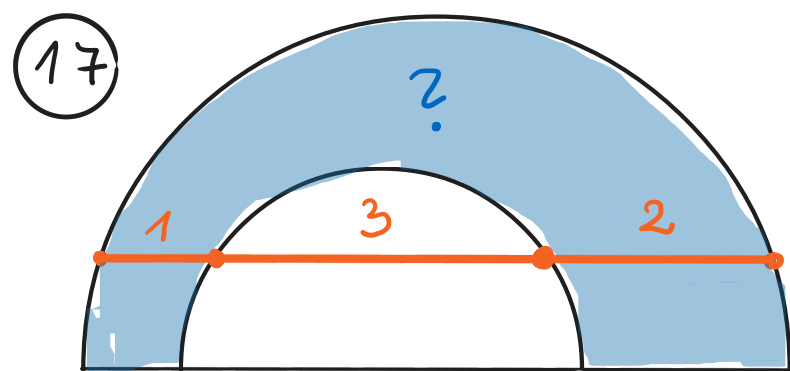

Ćwiczenia okręgów

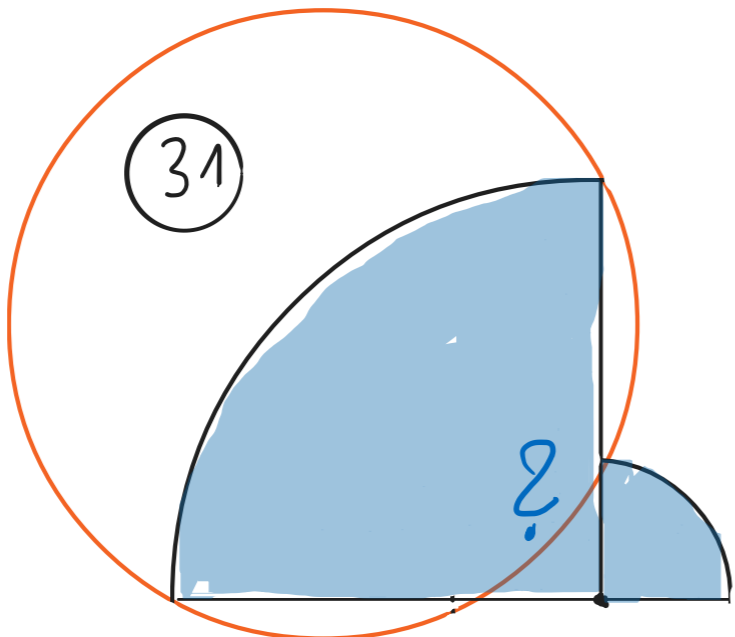
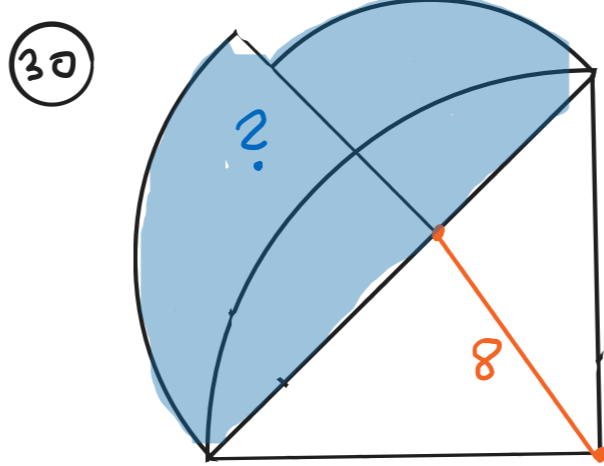
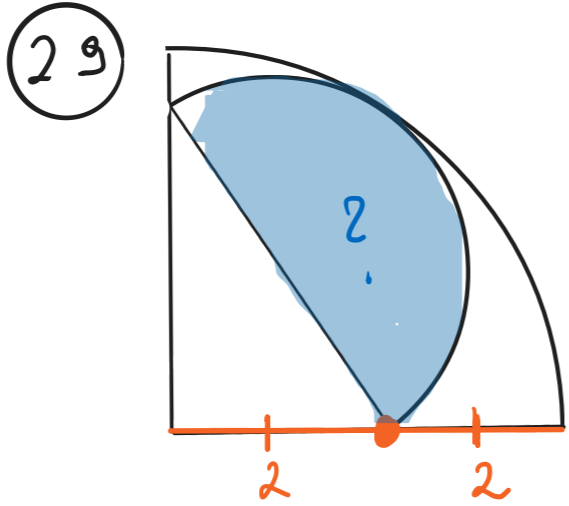
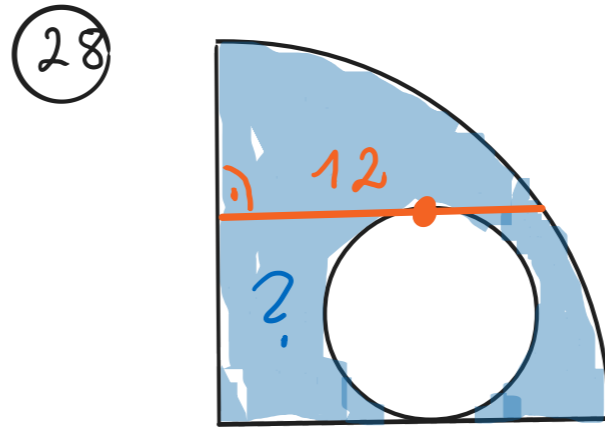
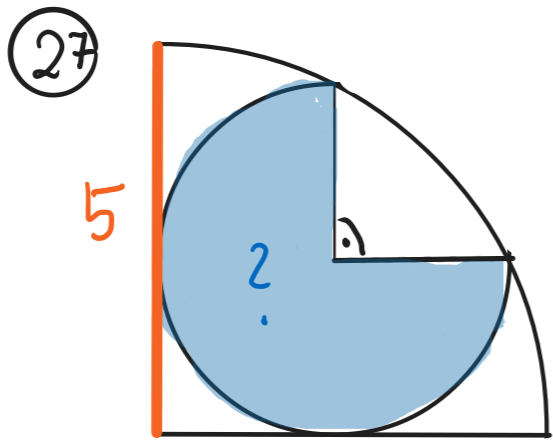
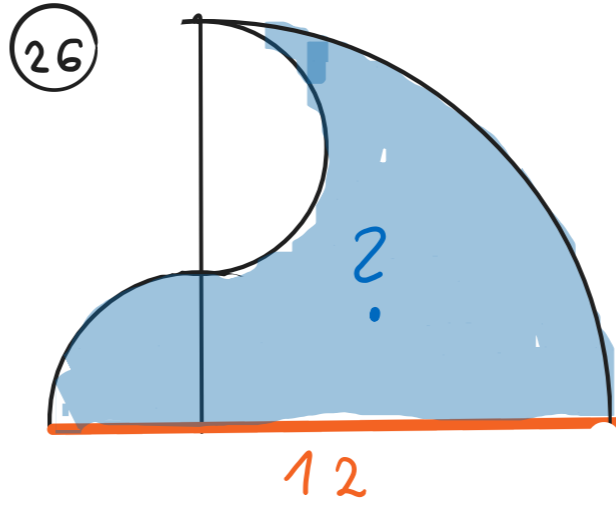
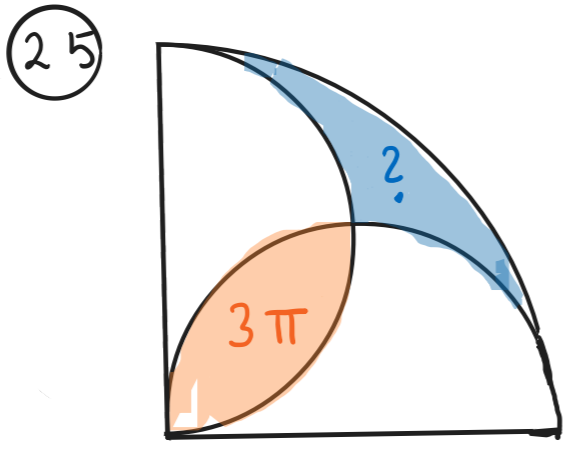

promień $0 = 4$

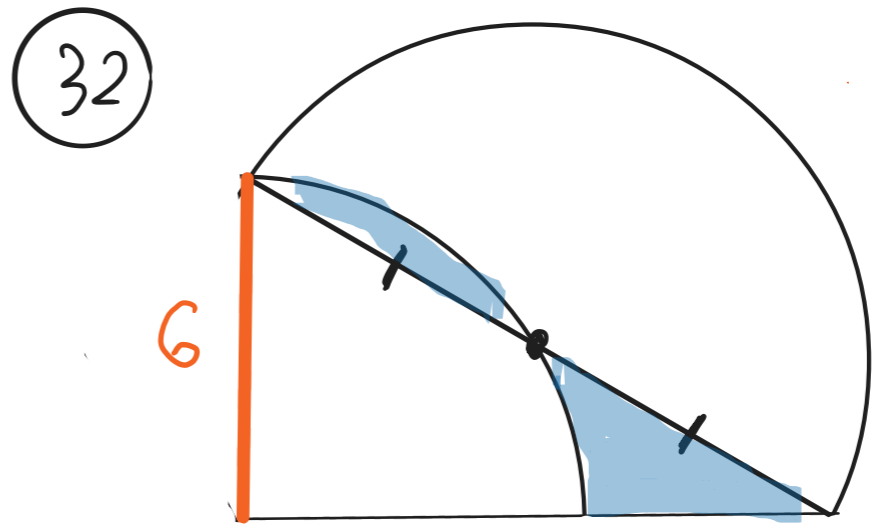

$\triangle = ?$

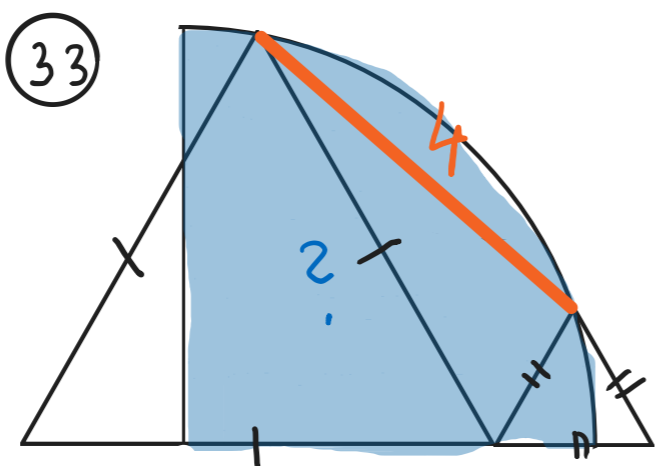

Źródła zadań.

1. Twitter, m.in. Catriona Agg.
2. Olimpiada Matematyczna Juniorów.
3. Liga zadaniowa Pompetition Junior.